

HYDRAULIC PATCH FITTINGS

- Quick & Easy Installation
- Adjustable Closing Speed



 Will Call Order:
905-760-2000

 Visit Our Website:
www.taghardware.ca 

 Sales Enquiries:
sales@taghardware.ca



ONE STOP SHOP

GLASS HARDWARE • GLASS FABRICATION • TECHNICAL SUPPORT • DELIVERY

Porch Enclosure



Pool Gates



Winecellar



Applications:



Commercial



Residential

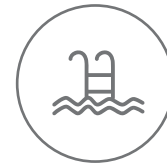

Pool Gates

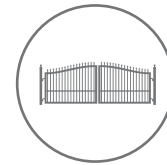

Safety Gates



Hospitals

Concealed Hydraulic Door Closer by Tag Hardware is a bottom patch fitting for doors that is easy to install and maintain. Unlike the conventional floor spring, the hydraulic patch fitting requires no cavity on the ground for installation making the process quick while saving cost on labor and creating an aesthetically appealing seamless doorway.

The absence of opening on the floor allows for a cleaner surface with minimal accumulation of dust or water making this product ideal for places requiring extra hygiene such as hospitality and healthcare industry.

Tag Hardware offers the largest selection of Hydraulic Door Closers to cater to various requirements depending on load capacity, temperature, indoor or outdoor applications, and finishes etc.

Best Price GUARANTEED

For best option recommendation contact Technical Sales at 905-760-2000 ext 231 or email at technical@taghardware.ca

Register online to get company Discount | www.taghardware.ca

Shipping Across U.S & Canada



ONE STOP SHOP

GLASS HARDWARE • GLASS FABRICATION • TECHNICAL SUPPORT • DELIVERY

Largest Selection of HYDRAULIC PATCH FITTINGS



You Name It, We Have It!!

Tag Hardware brings to you the largest selection of Concealed Hydraulic Patch Fittings at a **Great Value**.

Specifications:

- Quick & Easy Installation
- Opening Angle upto 140° Double Action
- Adjustable Closing Speed
- Adjustable Latching Speed on Adjustable Closing and Latching Speed
- Hold Open And Non Hold Open Options
- Base Plate Adjustment: 3mm L/R Up/Down
4° Alignment
- Available in Wide Range of Custom Finishes
- 2-9/16 (65mm) European Pivot Set Back

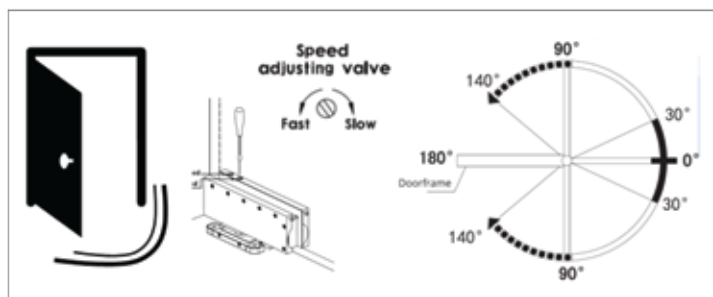
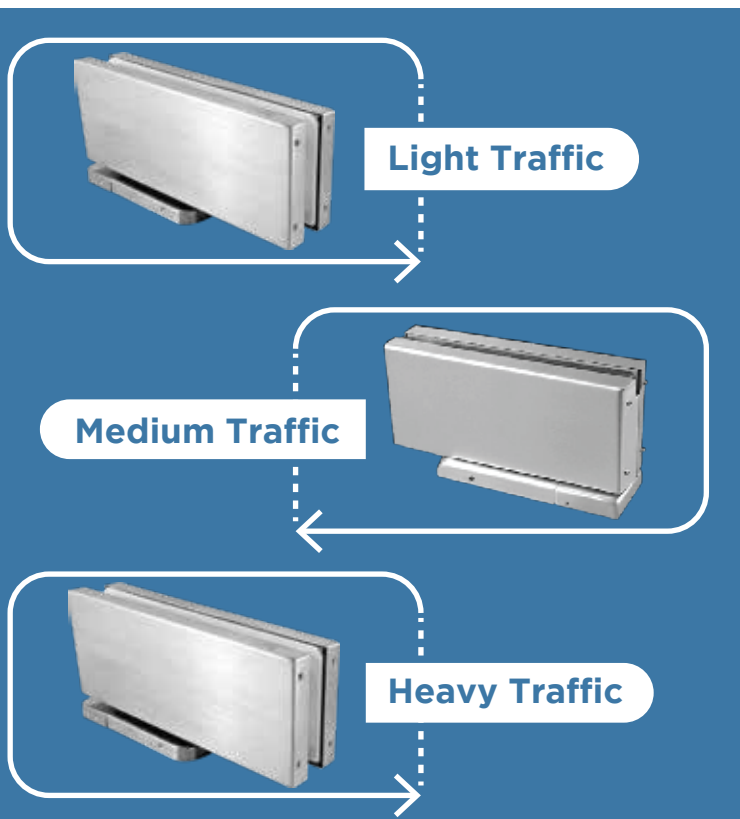

DOOR WEIGHT ✓

- ✎ ≤80 KG
- 🏋️ ≤100 KG
- 🏋️‍♀️ ≤150 KG

OPENING SPEED ✓

3 lb

5 lb

ADJUSTABLE

GLASS THICKNESS ✓

8mm to 15mm

DOOR WIDTH ✓

24" to 49"

ORDER GLASS AND HARDWARE FROM US
And Get Free CAD Drawing



MAKE YOUR LIFE
SIMPLE!

ONE STOP SHOP

GLASS HARDWARE • GLASS FABRICATION • TECHNICAL SUPPORT • DELIVERY

ORDER MADE EASY



Set Code

CDB80



Max 80Kg. (176lbs)
Glass Door Weight Capacity



8-12mm (5/16"-1/2")
Door Thickness

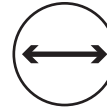

635-762mm (25"-30")
Door Width

PRODUCTS USED IN THIS SET



FSACCGDP
Top Pivot for Patch



PF2
Top Patch



GH112X12
Glass Door Handle



CFHB80
Hydraulic Patch Fitting



Buy This Set Online

Finishes Available:



Brushed Stainless Steel (BSS)



Polished Stainless Steel (PSS)

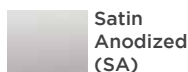

Satin Anodized (SA)



Matt Black (MBL)



Custom Finishes

Please specify finish while ordering



Now Easily Shop Online taghardware.ca



1000s of Products Shipping Across



Shower | Storefront | Entrance Railing | Sliding | And More...
Wide range of custom finishes available

ONE STOP SHOP

GLASS HARDWARE • GLASS FABRICATION • TECHNICAL SUPPORT • DELIVERY

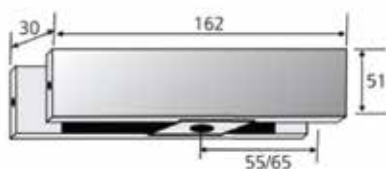
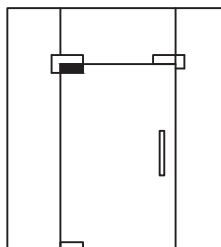

PF2
Top Door Patch
Fitting

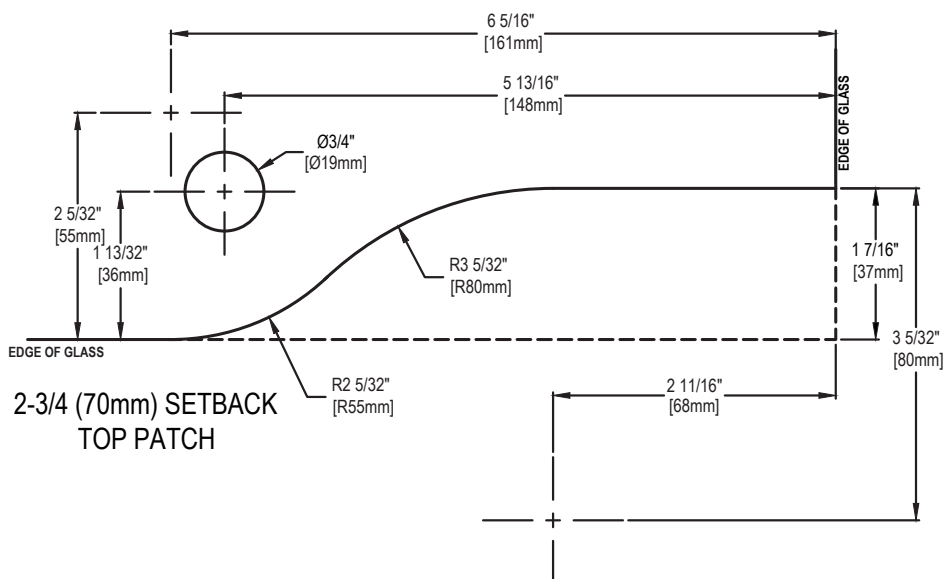

CFHB80
Hydraulic Patch Fitting

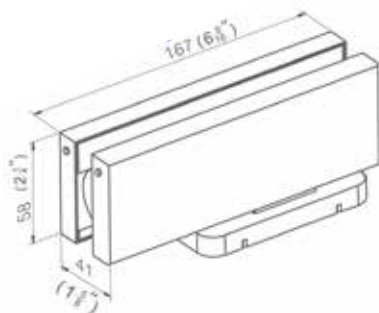
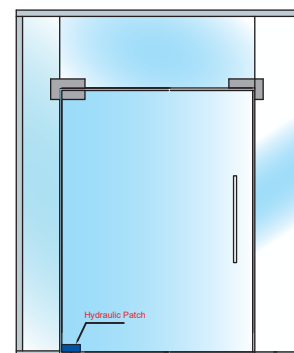
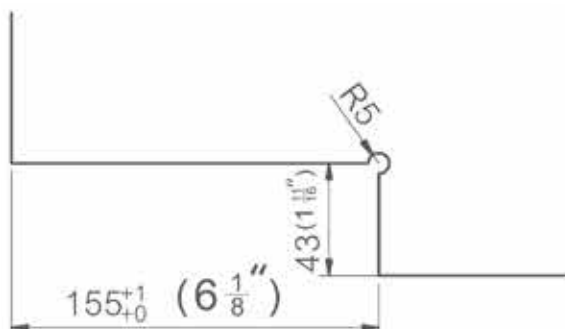

Disclaimer:

While Tag Hardware endeavours to provide you with correct information, mistakes and typographical errors cannot be eliminated 100%. We do our best to provide you with accurate information but completeness and accuracy cannot be guaranteed.

SHOWER | STOREFRONT | ENTRANCE | RAILING | SLIDING | AND MORE...

ONE STOP SHOP

GLASS HARDWARE • GLASS FABRICATION • TECHNICAL SUPPORT • DELIVERY



ORDER MADE EASY



Set Code
CD100

Max 100Kg. (220lbs)
Glass Door Weight Capacity

8-12mm (5/16"-1/2")
Door Thickness

Max 1016mm (40inch)
Door Width

Option: Upto 150° Hold Open

PRODUCTS USED IN THIS SET



PF1
Transom Patch (Pivot)



PF2
Top Patch



PF610
Transom Patch (Door Stop)



CFH100
Hydraulic Patch Fitting

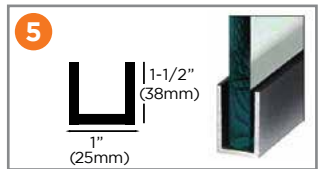

E3UC15X1
1-1/2 x 1 Channel

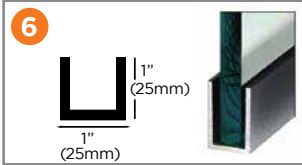

E3UC1X1
1 x 1 Channel



Buy This Set Online

Finishes Available:

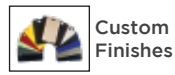

Please specify finish while ordering

Best Price GUARANTEED

For best option recommendation contact Technical Sales at 905-760-2000 ext 231 or email at technical@taghardware.ca

Register online to get company Discount | www.taghardware.ca

Shipping Across U.S & Canada



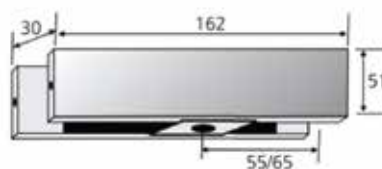
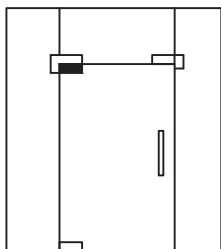

PF2
Top Door Patch Fitting

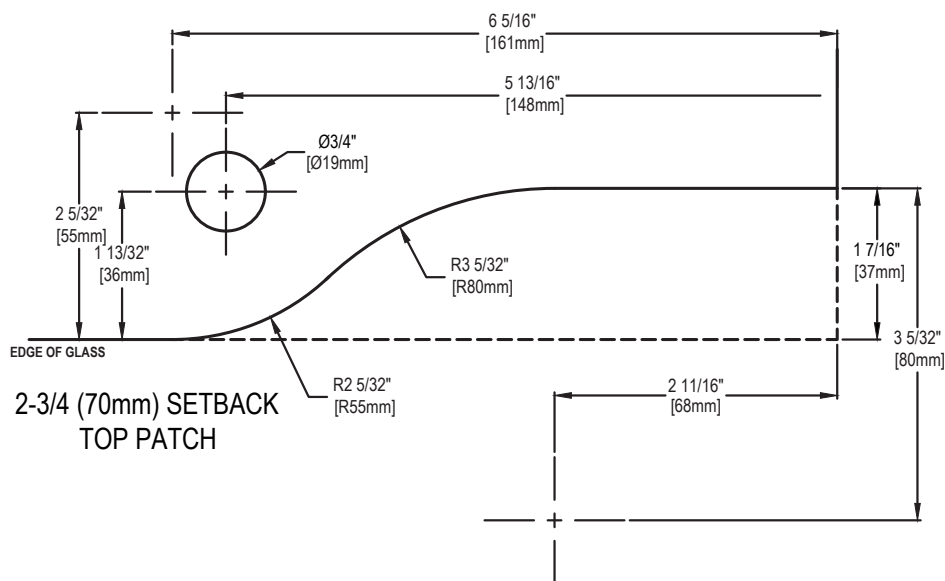

CFH100
Hydraulic Patch Fitting

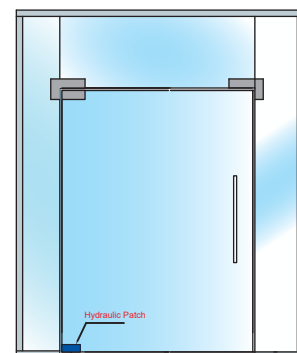
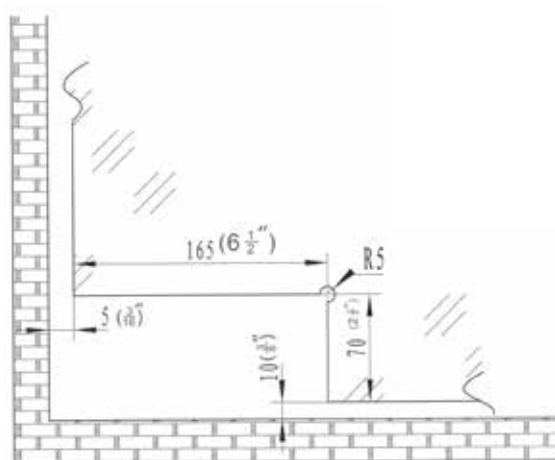

Disclaimer:

While Tag Hardware endeavours to provide you with correct information, mistakes and typographical errors cannot be eliminated 100%. We do our best to provide you with accurate information but completeness and accuracy cannot be guaranteed.

ORDER GLASS AND HARDWARE FROM US
And Get Free CAD Drawing



MAKE YOUR LIFE
SIMPLE!

ONE STOP SHOP

GLASS HARDWARE • GLASS FABRICATION • TECHNICAL SUPPORT • DELIVERY



ORDER MADE EASY



Set Code

CDP100



Max 100Kg. (220lbs)
Glass Door Weight Capacity



10-15mm (29-1/2" - 39-3/8")
Door Thickness

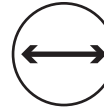

750-1000mm (29-1/2" - 39-3/8")
Door Width

PRODUCTS USED IN THIS SET



FSACCGDP
Top Pivot for Patch



PF2
Top Patch



LH24X24
(36" Overall)
Ladder Handle



CFHP100
Hydraulic Patch Fitting



Buy This Set Online

Finishes Available:



Brushed Stainless Steel (BSS)



Polished Stainless Steel (PSS)



Satin Anodized (SA)



Matt Black (MBL)



Custom Finishes

Please specify finish while ordering



Now Easily Shop Online
taghardware.ca



1000s of Products Shipping Across



Shower | Storefront | Entrance Railing | Sliding | And More...
Wide range of custom finishes available

ONE STOP SHOP
GLASS HARDWARE • GLASS FABRICATION • TECHNICAL SUPPORT • DELIVERY

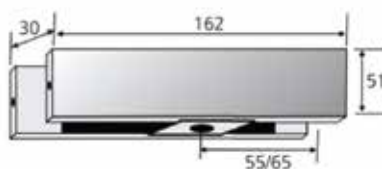
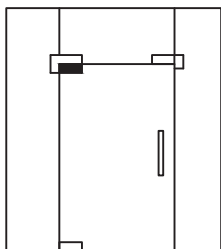

PF2
Top Door Patch Fitting

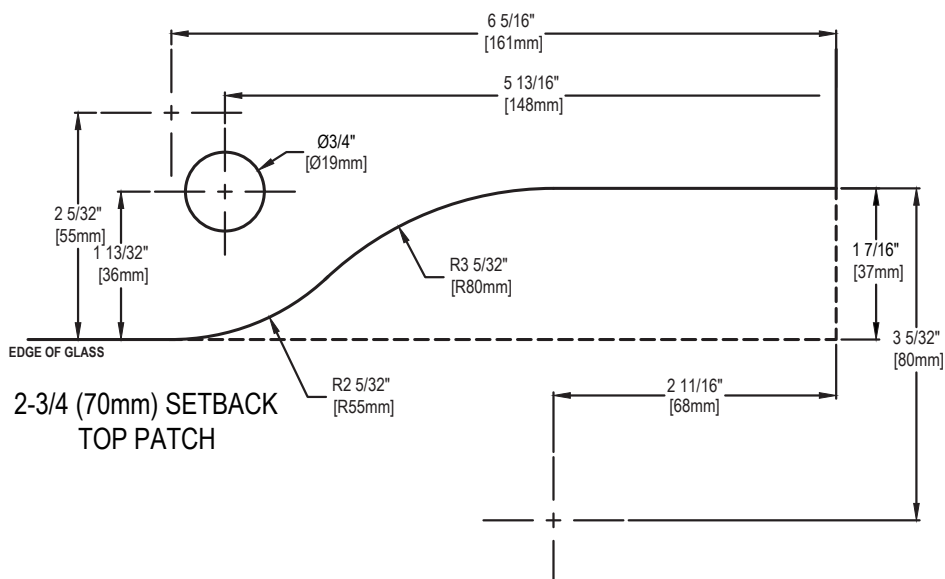

CFHP100
Hydraulic Patch Fitting

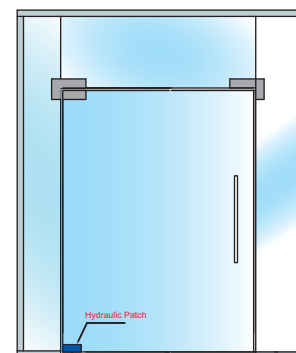
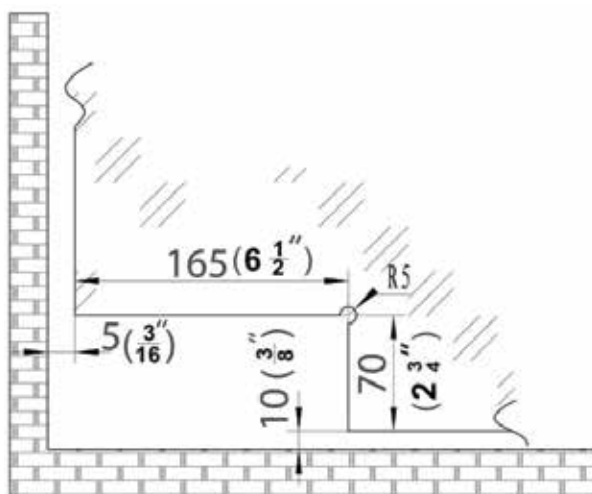

Disclaimer:

While Tag Hardware endeavours to provide you with correct information, mistakes and typographical errors cannot be eliminated 100%. We do our best to provide you with accurate information but completeness and accuracy cannot be guaranteed.

SHOWER | STOREFRONT | ENTRANCE | RAILING | SLIDING | AND MORE...

ONE STOP SHOP

GLASS HARDWARE • GLASS FABRICATION • TECHNICAL SUPPORT • DELIVERY

ORDER MADE EASY



Set Code

CD105



Max 100Kg. (220lbs)
Glass Door Weight Capacity



10-15mm (3/8"-9/16")
Door Thickness

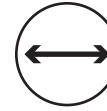

Max 1200mm (47-1/4")
Door Width

PRODUCTS USED IN THIS SET



CFH105MBL
Hydraulic Patch Fitting



FSACCGDPBL
Top Pivot



PF2BL
Top Patch



PL2ABL
Patch Lock



LH12X12BL
Door Handle

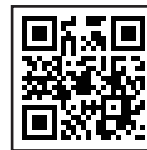

Buy This Set Online

Finishes Available:



Brushed
Stainless Steel
(BSS)



Polished
Stainless Steel
(PSS)

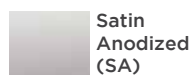

Satin
Anodized
(SA)



Matt
Black
(MBL)



Custom
Finishes

Please specify finish while ordering

Best Price GUARANTEED

For best option recommendation contact Technical Sales at 905-760-2000 ext 231 or email at technical@taghardware.ca

Register online to get company Discount | www.taghardware.ca

Shipping Across
U.S & Canada



ONE STOP SHOP

GLASS HARDWARE • GLASS FABRICATION • TECHNICAL SUPPORT • DELIVERY



PF1
Transom Patch (Pivot)

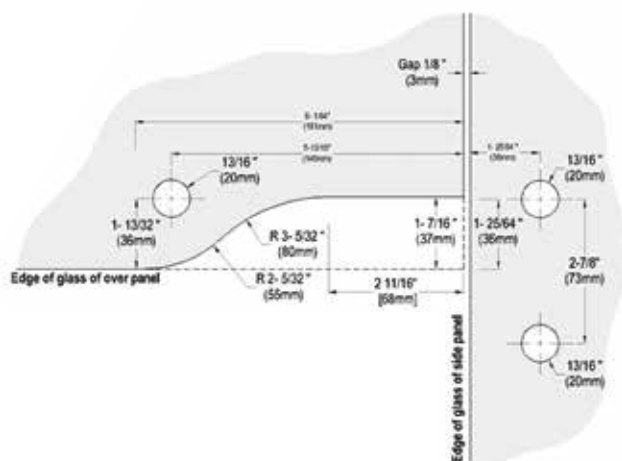

PF2
Top Patch

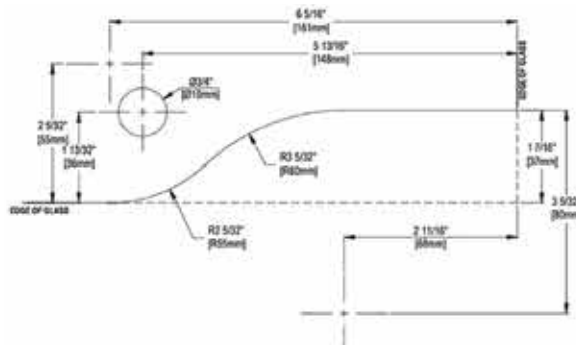

PL2A
Patch Lock

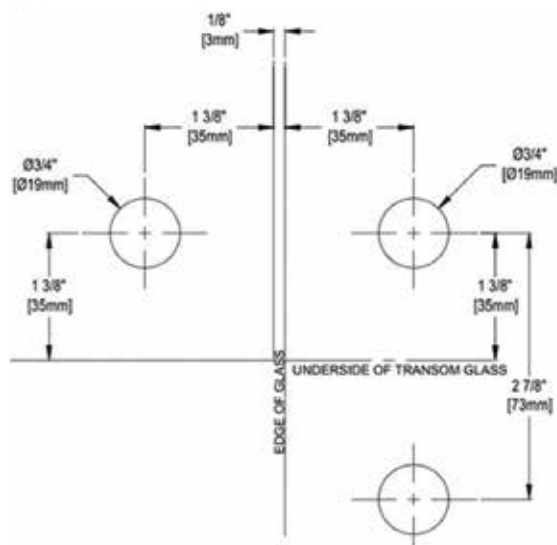

CFH105
Hydraulic Patch Fitting

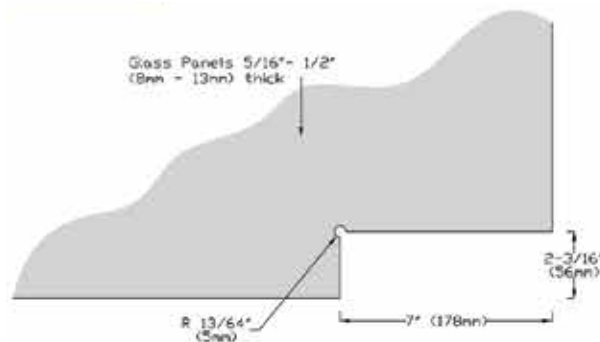

Disclaimer:

While Tag Hardware endeavours to provide you with correct information, mistakes and typographical errors cannot be eliminated 100%. We do our best to provide you with accurate information but completeness and accuracy cannot be guaranteed.

ORDER GLASS AND HARDWARE FROM US
And Get Free CAD Drawing



MAKE YOUR LIFE
SIMPLE!

ONE STOP SHOP

GLASS HARDWARE • GLASS FABRICATION • TECHNICAL SUPPORT • DELIVERY

ORDER MADE EASY



Set Code

CD135



Max 100Kg. (220lbs)
Glass Door Weight Capacity



10-15mm (3/8"-9/16")
Door Thickness

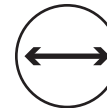

Max 1200mm (47-1/4")
Door Width

PRODUCTS USED IN THIS SET



CFH135MBL
Hydraulic Patch Fitting



PF1BL
Transom Patch (Pivot)



PF2BL
Top Patch



FSACCGDPBL
Top Pivot



PL205BL
Center Lock



PL2ABL
Patch Lock



LH12X12BL
Door Handle



Buy This Set Online

Finishes Available:

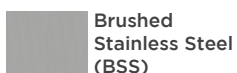

Brushed
Stainless Steel
(BSS)



Polished
Stainless Steel
(PSS)

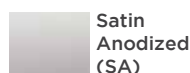

Satin
Anodized
(SA)

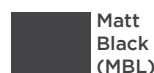

Matt
Black
(MBL)

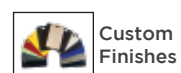

Custom
Finishes

Please specify finish while ordering



Now Easily
Shop Online
taghardware.ca



1000s of Products
Shipping Across



Shower | Storefront | Entrance
Railing | Sliding | And More...
Wide range of custom finishes available

ONE STOP SHOP

GLASS HARDWARE • GLASS FABRICATION • TECHNICAL SUPPORT • DELIVERY



PF1
Transom Patch (Pivot)

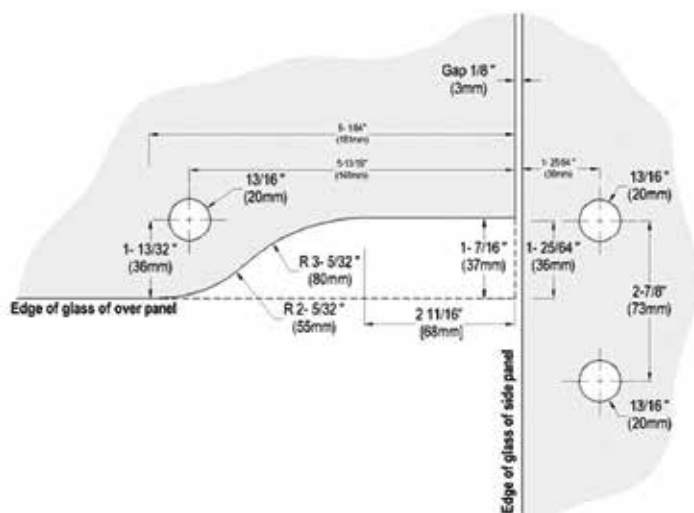

PF2
Top Patch

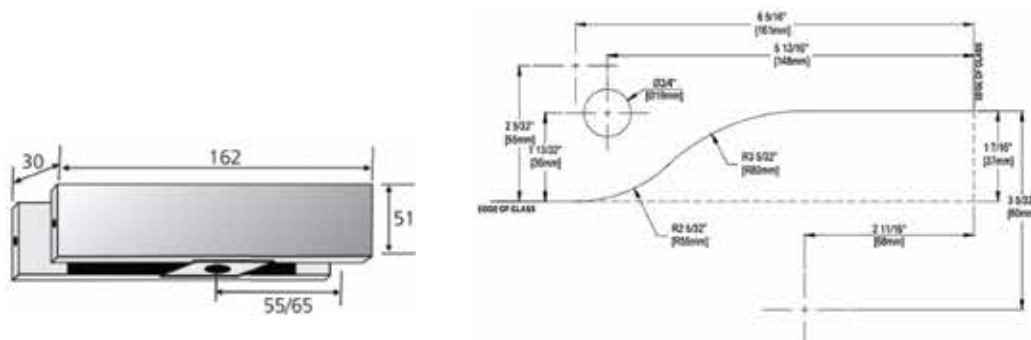

PL2A
Patch Lock

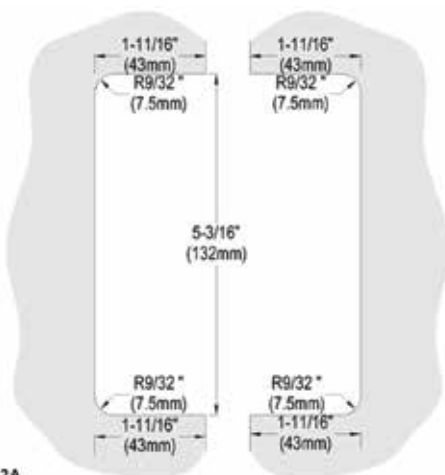

PL205
Center Lock



CFH135
Hydraulic Patch Fitting

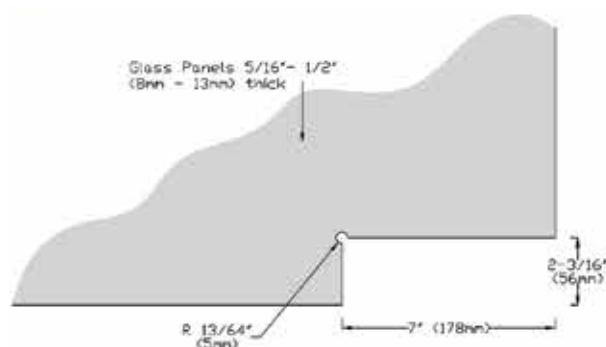

Disclaimer:

While Tag Hardware endeavours to provide you with correct information, mistakes and typographical errors cannot be eliminated 100%. We do our best to provide you with accurate information but completeness and accuracy cannot be guaranteed.

SHOWER | STOREFRONT | ENTRANCE | RAILING | SLIDING | AND MORE...

ONE STOP SHOP

GLASS HARDWARE • GLASS FABRICATION • TECHNICAL SUPPORT • DELIVERY

ORDER MADE EASY



Set Code

CDP150



Max 150Kg. (330lbs)
Glass Door Weight Capacity



10-15mm (3/8"-9/16")
Door Thickness

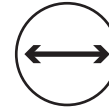

Max 1000mm (40")
Door Width

PRODUCTS USED IN THIS SET



PF1
Transom Patch (Pivot)



PF2
Top Patch



LH12X12
Glass Door Handle



CFHP150
Hydraulic Patch Fitting

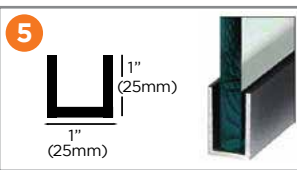

E3UC15X1BN12

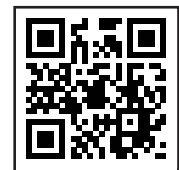

Buy This Set Online

Finishes Available:



Brushed Stainless Steel (BSS)



Polished Stainless Steel (PSS)

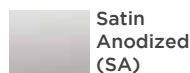

Satin Anodized (SA)



Matt Black (MBL)



Custom Finishes

Please specify finish while ordering

Best Price GUARANTEED

For best option recommendation contact Technical Sales at 905-760-2000 ext 231 or email at technical@taghardware.ca

Register online to get company Discount | www.taghardware.ca

Shipping Across U.S & Canada



ONE STOP SHOP

GLASS HARDWARE • GLASS FABRICATION • TECHNICAL SUPPORT • DELIVERY



PF1
Transom Patch (Pivot)

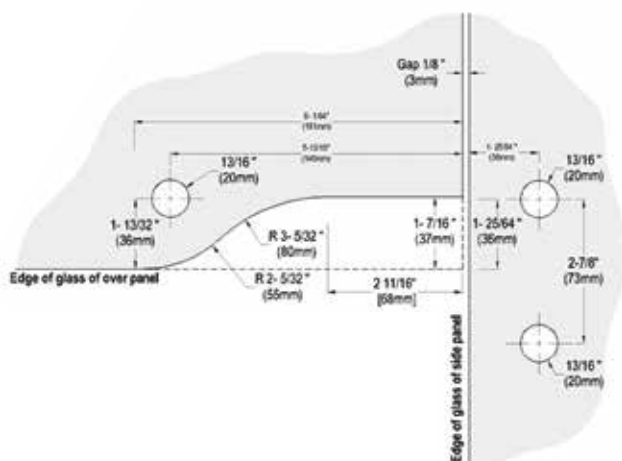

PF2
Top Door Patch Fitting

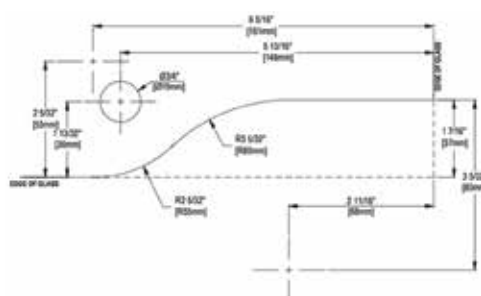

LH12X12
Glass Door Handle

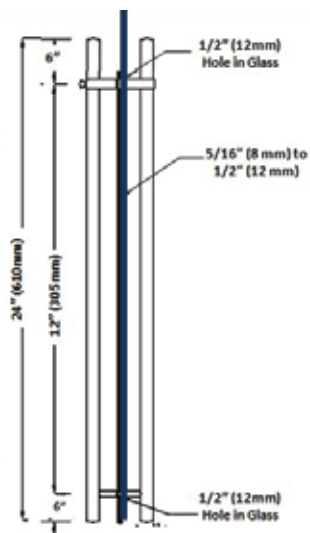

CFHP150
Hydraulic Patch Fitting

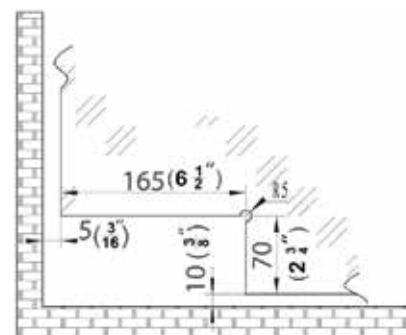

Disclaimer:

While Tag Hardware endeavours to provide you with correct information, mistakes and typographical errors cannot be eliminated 100%. We do our best to provide you with accurate information but completeness and accuracy cannot be guaranteed.

ORDER GLASS AND HARDWARE FROM US
And Get Free CAD Drawing



MAKE YOUR LIFE
SIMPLE!

ONE STOP SHOP

GLASS HARDWARE • GLASS FABRICATION • TECHNICAL SUPPORT • DELIVERY

COMMERCIAL PATCH HARDWARE



PF1
Sidelite Transom Patch
With Pivot



PF2
Top Door Patch
Fitting

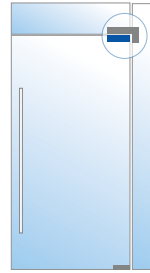

PF3
Bottom Door Patch
Fitting

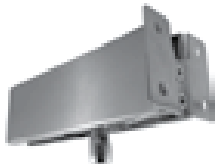
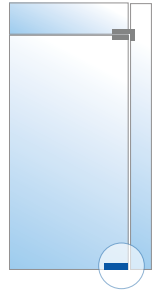

PF4
Wall Mounted Transom
Patch with Pivot

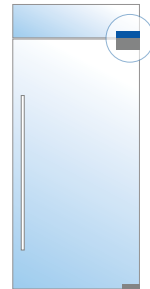

PF610
Sidelite Mounted Transom
Patch With Door Stop

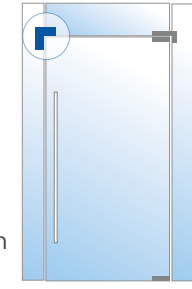

PF2HP
Top Door Patch Fitting
With Matching Plate

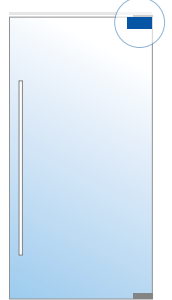

PF620
Quadruple Patch
Connector

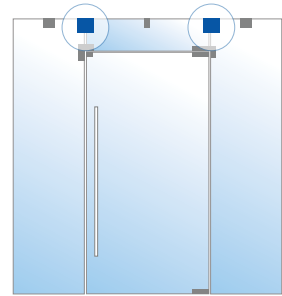

PF650
Glass to Glass
Connecting Patch

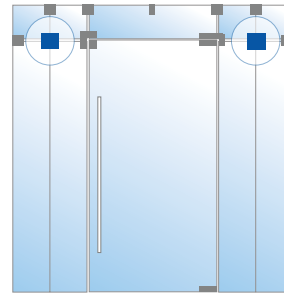

PF4
Top Door Patch Fitting
With Matching Plate as
CFH105

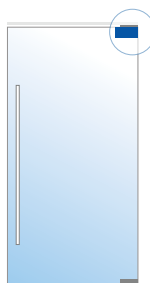

PF610
Top Centre Hung
Free Swing Pivot

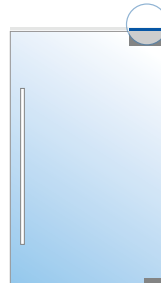

PF2HP
Floor Mounted
Bottom Pivot

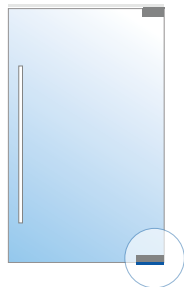

PATCH LOCKS



PL1
Corner Patch Lock
with Strike Plate



PL2
Centre Patch Lock &
Strike Box



PL205
Round Throw Bolt Patch
Lock With Strike Plate



PL3A
Thumb Turn Lock



PL3A/3B
Thumb Turn Lock
& Strike Box



PL4A
Glass Door Lock
Strike Plate



PL4A4B
Glass to Glass Door
Lock with Strike Box



PL5A
Double Sided Lock
With Strike Plate



PL5A5B
Double Sided Lock
with Strike Box



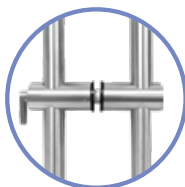

PRODUCT CODE	OVER ALL LENGTH	CENTER TO CENTER
LH8x8BS	12"(305mm)	8"(203mm)
LH8x8PS	12"(305mm)	8"(203mm)
LH12x12BS	24"(510mm)	12"(305mm)
LH12x12PS	24"(510mm)	12"(305mm)
LH12x12BL	24"(510mm)	12"(305mm)
LH18x18BS	30"(762mm)	18"(457mm)
LH18x18PS	30"(762mm)	18"(457mm)
LH24x24BS	36"(914mm)	24"(610mm)
LH24x24PS	36"(914mm)	24"(610mm)
LH36x36BS	48"(1219mm)	36"(914mm)
LH36x36PS	48"(1219mm)	36"(914mm)
LH48x48BS	60"(1524mm)	48"(1219mm)
LH48x48PS	60"(1524mm)	48"(1219mm)
LH48X48BL	60"(1524mm)	48"(1219mm)
LH60x60BS	72"(1829mm)	60"(1524mm)
LH60x60PS	72"(1829mm)	60"(1524mm)
LH72x72BS	84"(2134mm)	72"(1829mm)
LH72x72PS	84"(2134mm)	72"(1829mm)

PRODUCT CODE	CONVERT KIT TO CHANGE LADDER
LHOFFSETBS	Offset Mount Mid-Post for Ladder Pulls
LHOFFSETPS	

PRODUCT CODE	OVER ALL LENGTH	CENTER TO CENTER
GH1112X12BS	13"(337mm)	12"(305mm)
GH1112X12PS	13"(337mm)	12"(305mm)
GH1124X24BS	25"(642mm)	24"(610mm)
GH1124X24PS	25"(642mm)	24"(610mm)
GH1136X36BS	37"(946mm)	36"(914mm)
GH1136X36PS	37"(946mm)	36"(914mm)
GH1160X60BS	61"(1556mm)	60"(1524mm)
GH1160X60PS	61"(1556mm)	60"(1524mm)
GH1172X72BS	73"(1861mm)	72"(1829mm)
GH1172X72PS	73"(1861mm)	72"(1829mm)

PRODUCT CODE	OVER ALL LENGTH	CENTER TO CENTER
HOFF10X10BS	10"(254mm)	Door Handle Offset 10x10" in BSS
HOFF12X12BS	12"(304mm)	Door Handle Offset 12x12" in BSS
HOFF18X18BS	18"(457mm)	Door Handle Offset 16x16" in BSS

PRODUCT CODE	OVER ALL LENGTH	CENTER TO CENTER
LHL1125x1125BS	59-1/16" (1500mm)	44-5/16" (1125mm)
LHL3612x3612BS	60" (1524mm)	36" (914.4mm)
LHL3612x3612PS	60" (1524mm)	36" (914.4mm)
LHL36x36BS	48" (1219mm)	36" (914mm)
LHL36x36PS	48" (1219mm)	36" (914mm)

**BS - BRUSHED STAINLESS STEEL . PS - POLISHED STAINLESS STEEL . SA - SATIN ANODIZED.
BL - Matt Black (available on request)**



Now Easily
Shop Online
taghardware.ca



1000s of Products
Shipping Across



Shower | Storefront | Entrance
Railing | Sliding | And More...
Wide range of custom finishes available

ONE STOP SHOP

GLASS HARDWARE • GLASS FABRICATION • TECHNICAL SUPPORT • DELIVERY

Keyless Security with Smart Locks



Unlocking Options:

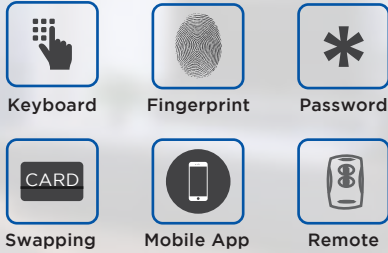

ORDER ONLINE

www.taghardware.ca

Features:

- High Definition Color Screen
- One Card Solution
- Optical Fingerprint Head
- Voice Navigation
- Mechanical Knob Switch
- Alarm Locking
- Door Bell Function
- Low Energy Consumption

READY TO SHIP MODEL

CENTER LOCKS & KEEPERS



- Electric Strike 12v. or 24v.
- Glass Cutout Required
- High Security Cylinder

ORDER ONLINE
taghardware.ca

READY TO SHIP



- 5" x 10" in brushed SS finish
- For 1/2" tempered glass
- Simple glass cutout required
- Easy installation without use of silicone
- Master keys available upon request
- Application: Main Entrance Office
- Mechanism available to be compatible with card readers and high security systems



Custom Finish Available On Request

Enjoy the show in **Real HD** with the new **NINFA⁴**



NINFA IS HERE





Model No	Type	Application	Door Weight (max)		Door Height (max)		Door Width (max)		Glass Thickness (max)	
			KG	LBS	MM	IN	MM	IN	MM	IN
		Indoor/Outdoor								
CFHB80	Light	Indoor	80	176.4		84	900	35-7/16	8-12	5/16-1/2
CFH100	Medium	Indoor	100	220.4	2591	102	1000	39-3/8	8-12	5/16-1/2
CFHP100	Medium	Indoor/Outdoor	100	220.4	2591	102	1000	39-3/8	10-15	3/8-9/16
CFH105	Heavy Duty	Indoor	100	220.4	2591	102	1250	49-7/36	10-15	3/8-9/16
CFH135	Heavy Duty	Indoor	100	220.4	2591	102	1250	49-7/32	10-15	3/8-9/16
CFHP150	Premium Heavy Duty	Indoor/Outdoor	150	330.6	2591	102	1250	49-7/32	10-15	3/8-9/16

Options for Hold open or Non Hold Open

*Conditions May Apply

Finishes Available:

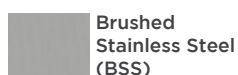

Brushed
Stainless Steel
(BSS)



Polished
Stainless Steel
(PSS)



Satin
Anodized
(SA)



Matt
Black
(MBL)



Custom
Finishes

Please specify finish while ordering

SHOWER | STOREFRONT | ENTRANCE | RAILING | SLIDING | AND MORE...

ONE STOP SHOP



GLASS HARDWARE • GLASS FABRICATION • TECHNICAL SUPPORT • DELIVERY

 **CANADA**

Hardware Sales & Pickup





TAG HARDWARE

-  311 Bowes Road, Unit B6,
Vaughan L4K 1J1
-  905-760-2000
-  sales@taghardware.ca

Hardware Sales & Pickup



TAG RAILING





-  311 Bowes Road, Unit B3,
Vaughan L4K 1J1
-  905-760-2000
-  sales@tagrailing.com

Glass Sales & Pickup



**IN-HOUSE GLASS
FABRICATION**

VAUGHAN GLASS AND MIRROR INC.

-  88 Villarboit Crescent, Unit 2,
Concord, Ontario L4K 4K2
-  905-597-GLAS(4527)
-  905-597-4521
-  sales@vglassmirror.com



 **USA**

Hardware Sales & Pickup



TAG HARDWARE LLC

-  11920 St. Johns Industrial, Parkway North, Suite 6,
Jacksonville, Florida FL - 32246
-  904-201-1059, 904-325-4877
-  salesusa@taghardware.ca

Register or Login to
create business account
www.taghardware.ca



Place Order



Pay Online
or In-Store



Request
a Quote



Manage
Your Account